

Ventilated facades with Viroc panels - Wooden structure

Screws for fixing Viroc panels

Panel thickness 12 mm

TORX PANEL TB16 TX20-4.8x38

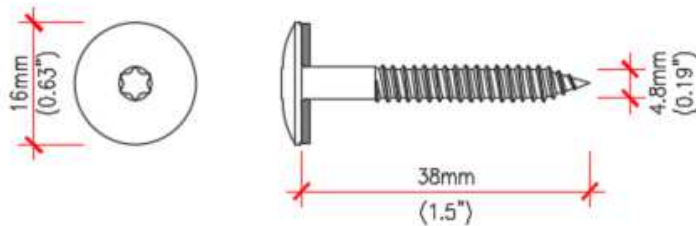

TORX PANEL TB12 TX20-4.8x38 A16

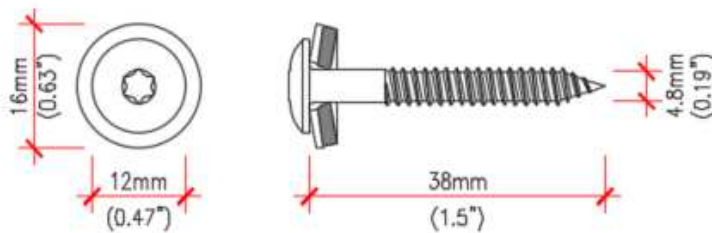

S-TET BOIS 4.8x36 -A16



			NATURAL head		PAINTED head	
			Austenitic stainless steel A4 Aisi 316		Austenitic stainless steel A4 Aisi 316	
			Resistance to corrosion > 30 Kesternich cycles		Resistance to corrosion > 30 Kesternich cycles	
			S-TET WOOD In A4 - Natural finish		S-TET WOOD In A4 - Painted	
Ø x L	Head Ø	Ø SS Vulca	Pack.	Code	Pack.	Code
4,8 x 36	14	-	100	265 052	100	265 053
4,8 x 36	14	14	100	265 054	100	265 055
4,8 x 36	14	16	100	265 056	100	265 057

Panel thickness 16mm

TORX PANEL TB12 TX20-4.8x60 A16

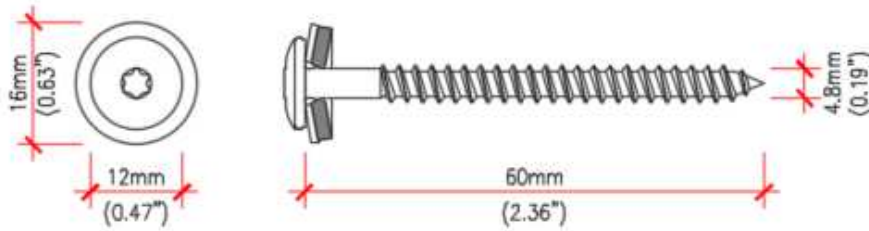

S-TET BOIS 4.8x60 -A16



			NATURAL head		PAINTED head	
			Austenitic stainless steel A4 Aisi 316 Resistance to corrosion > 30 Kesternich cycles		Austenitic stainless steel A4 Aisi 316 Resistance to corrosion > 30 Kesternich cycles	
			S-TET WOOD In A4 - Natural finish		S-TET WOOD In A4 - Painted	
Ø x L	Head Ø	Ø SS Vulca	Pack.	Code	Pack.	Code
4,8 x 60	14	-	100	265 060	100	265 061
4,8 x 60	14	14	100	265 062	100	265 062
4,8 x 60	14	16	100	265 064	100	265 065

Support brackets

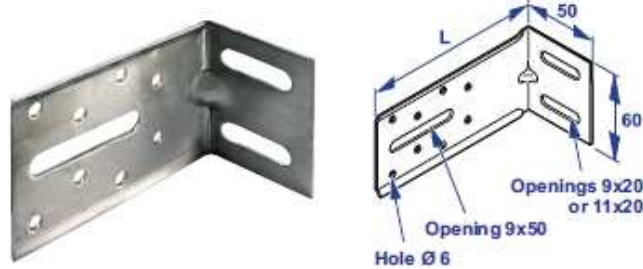

L	Z450 galvanized SG 220 GD steel 2.5 mm thickness ISOLCO 3000 P2 M8/Ga Opening 9x20		Z450 galvanized SG 220 GD steel 2.5 mm thickness ISOLCO 3000 P2 M10/Ga Opening 11x20	
	Pack.	Code	Pack.	Code
40	200	367 100	200	367 130
50	200	367 101	200	367 131
60	200	367 102	200	367 132
70	200	367 103	200	367 133
80	200	367 104	200	367 134
90	200	367 105	200	367 135
100	100	367 106	100	367 136
110	100	367 107	100	367 137
120	100	367 108	100	367 138
130	100	367 109	100	367 139
140	100	367 110	100	367 140
150	100	367 111	100	367 141
160	100	367 112	100	367 142
170	100	367 113	100	367 143
180	100	367 114	100	367 144
190	100	367 115	100	367 145
200	50	367 116	50	367 146
210	50	367 117	50	367 147
220	50	367 118	50	367 148
230	50	367 119	50	367 149
240	50	367 120	50	367 150
250	50	367 121	50	367 151
260	50	367 122	50	367 152
270	50	367 123	50	367 153
280	50	367 124	50	367 154
290	50	367 125	50	367 155
300	50	367 126	50	367 156

Anchoring (bracket-wall)

MARCOVIS FM-X5 TH 13 10/15x85, (1 un/bracket)

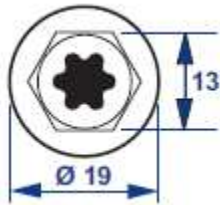

Polyamide PA6  
+ Screw in Carbon steel class 5.8  
zinc plated  $\geq 5 \mu\text{m}$

**MARCOVIS FM-X5  
TH 13**

$\emptyset$ / t <sub>tr</sub> x l	d	Screw l <sub>s</sub>	d <sub>0</sub>	h <sub>1</sub>	Pack.	Code
10 / 15 x 85	/	90	10	80	Bucket 300	360 601

Screws (bracket-wood profile)

TIREFOND TH/SH 7x50, (2 un/bracket)



**SHERARDISÉ**

Acier shéardisé  
Résistance à la corrosion  
600 heures au B.S.

**TIREFOND TH/SH**

$\emptyset$ x L	H	Cond.	Code
7 x 50	13	100	19 802

Band PVC or EPDM

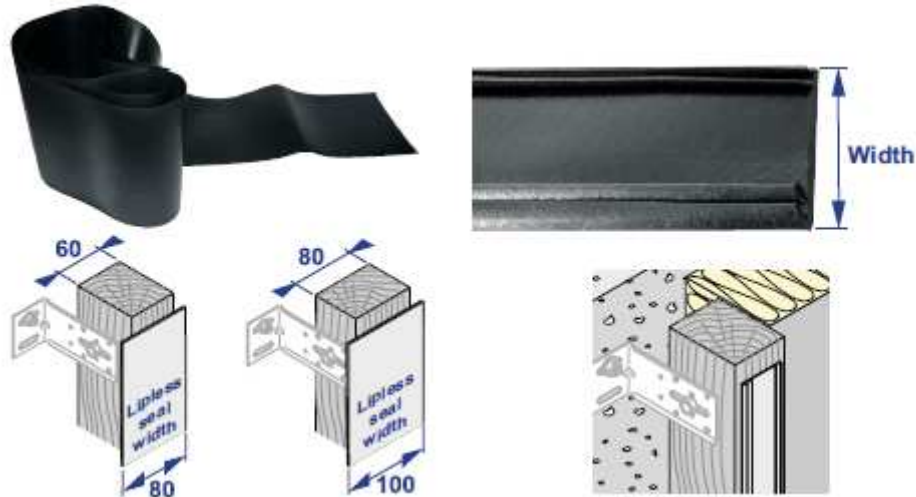

USTB  
3316

					Coloured PVC or EPDM	
					FLEXIBLE LIPLESS SEAL	
Width	Material	Thick.	Colour	Ral	Pack. (m)	Code
80	PVC	0,5	White	9010	50	366 520
80	PVC	0,5	Black	9011	50	366 523
80	EPDM*	0,8	Black	9011	50	366 536
100	PVC	0,5	White	9010	50	366 524
100	PVC	0,5	Black	9011	50	366 527
100	EPDM*	0,8	Black	9011	50	366 540
120	PVC	0,5	Black	9011	50	366 531

USTB  
3316

			Coloured PVC	
			PVC LIP SEAL	
Width	Colour		Pack. (m)	Code
38	White		50	366 501
38	Black		50	366 500
38	Grey		50	366 505
38	Brown		50	366 503
60	White		50	366 510
60	Black		50	366 512
60	Grey		50	366 516
60	Brown		50	366 514

Plastic anchor to fix the insulation

INCO Black

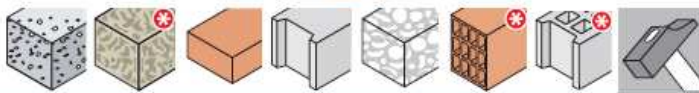
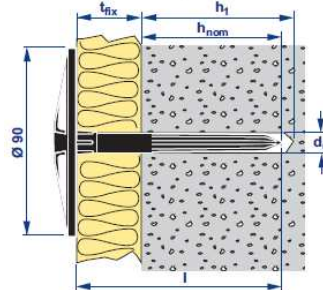

• Load: Up to 17 Kg



Black polypropylene

**INCO Black**

$\emptyset$ / $t_{fix}$ x $l$	$d_0^{\#}$	$h_1$	Pack.	Code
8 / 40 x 60	8	30	500	358 101
8 / 60 x 80	8	30	500	358 102
8 / 80 x 100	8	30	500	358 104
8 / 100 x 120	8	30	250	358 105
<hr/>				
10 / 40 x 70	10	40	500	358 170
10 / 60 x 90	10	40	500	358 172
10 / 80 x 110	10	40	250	358 174
10 / 110 x 140	10	40	200	358 176

Centering tool, ML 1000



**DRILL CENTRING TOOL  
ML 1000**

Model	Pack.	Code
Centring tool ML 1000	1	284 000

### Angle profile



Pre-painted Aluminium 1 mm thickness		
P.A.S. Al / PrL		
For panel thick. (mm)	Pack. (m) *	Code
10	30	611 700
15	30	611 702
20	30	611 704

(\*) Packaging: One 10 x 3 meters bundle, cannot be split

- Colours std.: RAL 1013 / 1015 / 7016 / 7035 / 9001 / 9007 / 9010 / 9016 - RAL Painting and other widths available on request
- Facade application:
  - Decorative corner profile



Pre-painted Aluminium 1 mm thickness		
P.A.R. Al / PrL		
For panel thick. (mm)	Pack. (m) *	Code
10	30	611 710
15	30	611 712
20	30	611 714

(\*) Packaging: One 10 x 3 meters bundle, cannot be split

- Colours std.: RAL 1013 / 1015 / 7016 / 7035 / 9001 / 9007 / 9010 / 9016 - RAL Painting and other widths available on request
- Facade application:
  - Decorative corner profile

### Corner plate

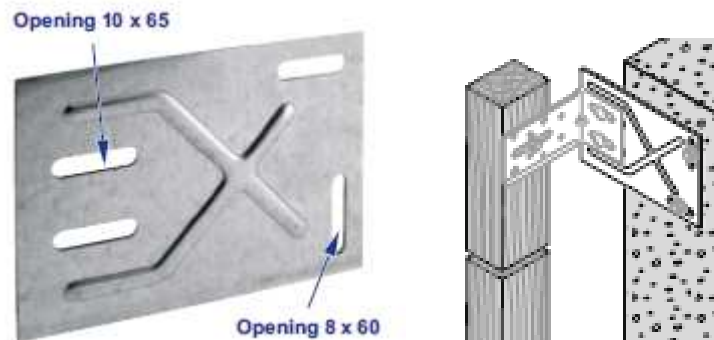

Galvanized steel Z 450 2.5 mm thickness		CORNER PLATE	
Ht	L	Pack.	Code
120	180	25	367 240

Anti-rodent profile



		Galvanized carbon steel	
		RODENT-PROOF GRILLE / Ga	
A	B	Pack.	Code
30	40	1	666 377
30	50	1	666 376
30	60	1	666 375
30	70	1	666 374
30	80	1	666 373
30	90	1	666 372
30	100	1	666 371
30	110	1	666 370
30	120	1	666 369
30	130	1	666 368
30	140	1	666 367
30	150	1	666 366
30	160	1	666 365
30	170	1	666 364
30	180	1	666 363
30	190	1	666 362
30	200	1	666 361
30	210	1	666 360
30	220	1	666 359
30	230	1	666 358
30	240	1	666 357
30	250	1	666 356
30	260	1	666 355





Contacts for information and supply

UK

T :+44 179 256 19 11

Portugal

Tel: +351 912 110 413

Email: [pedro.durao.etanco@gmail.com](mailto:pedro.durao.etanco@gmail.com)

France

T :+33 01 34 80 52 08

Email :[export@etanco.fr](mailto:export@etanco.fr)

Email :[commercial.france@etanco.fr](mailto:commercial.france@etanco.fr)

Etanco Belgium

T: +32 3 354 15 00

Etanco Germany

T: +49 27 39 47 99 64

Etanco Poland

T: + 48 55 24 22 926

Etanco Romania

T : +40 31 425 12 82

T : +40 72 264 69 44

Itály

T :+39 04 327 479 11

T :+39 02 990 480 62